

ОДНОНАПРАВЛЕННЫЙ НАСОС - СЕРИИ XV

XV-3P

ВАЛ ШЛИЦЕВОЙ
ФЛАНЕЦ Ø101,6 ТИП "SAE B"

X 3 P 78 32 I E E A

Серия	X	Серия XV
Группа	3	Группа 3
Категория	P	Однонаправленный насос
Рабочий объем	78	38
Фланец	32	Ø101,6 Тип "SAE B" с правым вращением
Вал	I	SCF04- Вал шлицевой - Ø21,81 z=13 H=33,55 SAE J498-13T 16/32DP (SAE B)
Корпус	Вход	Е
	Выход	Е
Крышка	A	Стандартная



XP331

Таблица технических характеристик

ТИП	Раб. Об. См³ /об	Макс. Давление P1 бар	P3 бар	КОД																	
				← Левое вращение								Правое вращение →									
				X	3	P	66	31	I	D	D	A	X	3	P	66	32	I	D	D	A
XV-3P/15	14,89	300	320	X	3	P	66	31	I	D	D	A	X	3	P	66	32	I	D	D	A
XV-3P/18	17,37	300	320	X	3	P	68	31	I	D	D	A	X	3	P	68	32	I	D	D	A
XV-3P/21	21,10	280	300	X	3	P	70	31	I	D	D	A	X	3	P	70	32	I	D	D	A
XV-3P/27	26,97	250	270	X	3	P	72	31	I	E	E	A	X	3	P	72	32	I	E	E	A
XV-3P/32	32,27	250	270	X	3	P	74	31	I	E	E	A	X	3	P	74	32	I	E	E	A
XV-3P/38	38,47	250	270	X	3	P	78	31	I	E	E	A	X	3	P	78	32	I	E	E	A
XV-3P/43	43,44	250	270	X	3	P	79	31	I	E	E	A	X	3	P	79	32	I	E	E	A
XV-3P/47	47,16	230	250	X	3	P	80	31	I	E	E	A	X	3	P	80	32	I	E	E	A
XV-3P/51	50,88	230	250	X	3	P	81	31	I	E	E	A	X	3	P	81	32	I	E	E	A
XV-3P/54	54,60	230	250	X	3	P	82	31	I	E	E	A	X	3	P	82	32	I	E	E	A
XV-3P/61	60,81	230	250	X	3	P	83	31	I	F	F	A	X	3	P	83	32	I	F	F	A
XV-3P/64	64,53	210	230	X	3	P	85	31	I	F	F	A	X	3	P	85	32	I	F	F	A
XV-3P/70	70,74	200	220	X	3	P	86	31	I	F	F	A	X	3	P	86	32	I	F	F	A
XV-3P/74	74,46	180	200	X	3	P	87	31	I	F	F	A	X	3	P	87	32	I	F	F	A
XV-3P/90	86,87	150	170	X	3	P	89	31	I	F	F	A	X	3	P	89	32	I	F	F	A

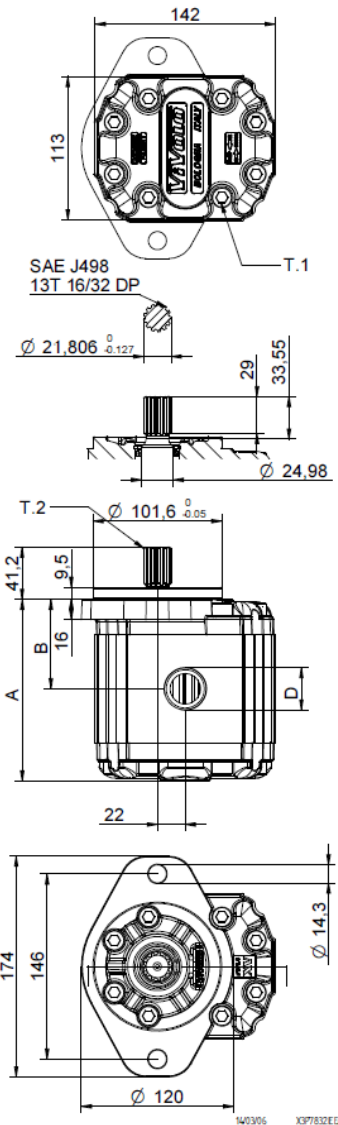

P1) Макс. рабочее давление - P3) Макс. пиковое давление
Для работы насоса в тяжелом режиме рекомендуется проверять допустимый крутящий момент на валу.

Таблица габаритов

ТИП	Вес кг	A мм	B мм	D	
				ВХОД	ВЫХОД
XV-3P/15	7,010	124,0	61,0	3/4" BSPP	3/4" BSPP
XV-3P/18	7,070	126,0	62,0	3/4" BSPP	3/4" BSPP
XV-3P/21	7,150	129,0	63,5	3/4" BSPP	3/4" BSPP
XV-3P/27	7,250	133,0	65,5	1" BSPP	1" BSPP
XV-3P/32	7,390	138,0	68,0	1" BSPP	1" BSPP
XV-3P/38	7,520	143,0	70,5	1" BSPP	1" BSPP
XV-3P/43	7,630	147,0	72,5	1" BSPP	1" BSPP
XV-3P/47	7,710	150,0	74,0	1" BSPP	1" BSPP
XV-3P/51	7,790	153,0	75,5	1" BSPP	1" BSPP
XV-3P/54	7,870	156,0	77,0	1" BSPP	1" BSPP
XV-3P/61	8,010	161,0	79,5	1" 1/4 BSPP	1" 1/4 BSPP
XV-3P/64	8,090	164,0	81,0	1" 1/4 BSPP	1" 1/4 BSPP
XV-3P/70	8,220	169,0	83,5	1" 1/4 BSPP	1" 1/4 BSPP
XV-3P/74	8,300	172,0	85,0	1" 1/4 BSPP	1" 1/4 BSPP
XV-3P/90	8,570	182,0	90,0	1" 1/4 BSPP	1" 1/4 BSPP

T.1 = 60÷65 [Н·м] - крутящий момент затяжки винтов M10
T.2 = 264 [Н·м] - допустимый крутящий момент на валу
(Примечание: Выбирая вал, всегда проверяйте допустимый крутящий момент).

Vivoil Oleodinamica Vivoil s.r.l. - Sole Shareholder Company - via Leone Ginzburg 2-4 40054 Budrio (BO) Italy tel: +39 051 803689 fax: +39 051 800061

XP331



www.vivoil.com - english

02/07/2009

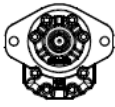
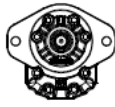
ФЛАНЕЦ Ø101,6 ТИП "SAE В"

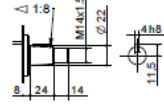
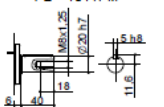
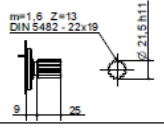
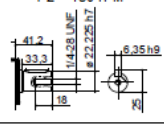
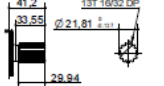
Фланец Ø101,6 Тип "SAE В"	
Левое Вращение	Правое Вращение
 31	 32

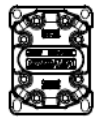
Вал	
CO001- Вал конический T 2 = 482 Н-м 	CI001- Вал цилиндрический T 2 = 181 Н-м 
SCF03- Вал шлицевой T 2 = 223 Н-м 	CI004- Вал цилиндрический T 2 = 180 Н-м 
SCF04- Вал шлицевой T 2 = 264 Н-м 	

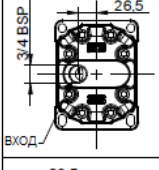
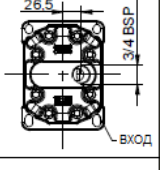
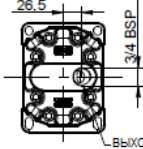
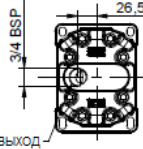
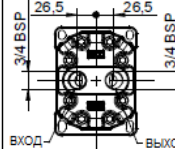
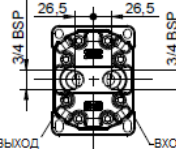
Крышка		
Левое Вращение	Правое Вращение	
		A
		B
		C
		D

Типоразмер	
ТИП	КОД
XV-3P/15	66
XV-3P/18	68
XV-3P/21	70
XV-3P/27	72
XV-3P/32	74
XV-3P/38	78
XV-3P/43	79
XV-3P/47	80
XV-3P/51	81
XV-3P/54	82
XV-3P/61	83
XV-3P/64	85
XV-3P/70	86
XV-3P/74	87
XV-3P/90	89

Стандартные корпуса				
Рабочий Объем См ³ /об	Стандартные резьбы			
	15	A - A	D - D	H - H
18	A - A	D - D	H - H	
21	A - A	D - D	H - H	
27	A - A	E - E	H - H	
32	B - B	E - E	H - H	
38	B - B	E - E	H - H	
43	B - B	E - E	H - H	
47	B - B	E - E	H - H	
51	B - B	E - E	H - H	
54	B - B	E - E	H - H	
61	C - C	F - F		
64	C - C	F - F		
70	C - C	F - F		
74	C - C	F - F		
90	C - C	F - F		

В таблице указаны имеющиеся в ассортименте комбинации стандартных фланцев и резьб.

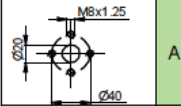
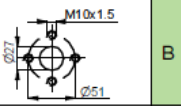
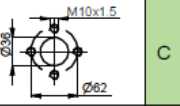
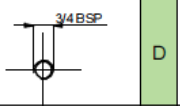
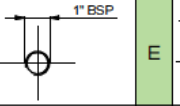
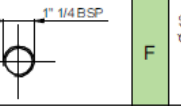
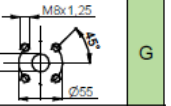
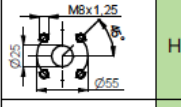
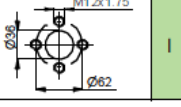
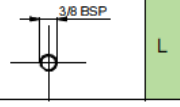
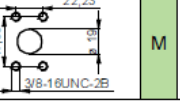
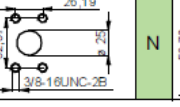
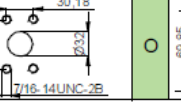
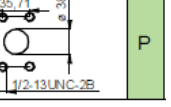
Корпус (резьбы/фланцы)													
	A		B		C		D		E		F		G
	H		I		L		M		N		O		P
Закрытый Корпус	Z												